

KENWOOD

KAC-PS200 KAC-PS150

POWER AMPLIFIER ▶ Page 2–12
INSTRUCTION MANUAL

AMPLIFICATEUR DE PUISSANCE ▶ Page 14–24
MODE D'EMPLOI

AMPLIFICADOR DE POTENCIA ▶ Page 26–36
MANUAL DE INSTRUCCIONES

KENWOOD CORPORATION

Take the time to read through this instruction manual.

Familiarity with installation and operation procedures will help you obtain the best performance from your new power amplifier.

For your records

Record the serial number, found on the back of the unit in the spaces designated on the warranty card, and in the space provided below. Refer to the model and serial numbers whenever you call upon your KENWOOD dealer for information or service on the product.

Model KAC-PS200/PS150 Serial number _____

Safety precautions

▲ WARNING

Take the following precautions to prevent fire and avoid personal injury :

- When extending the battery cable, or ground cable, use 5mm² (AWG10) or larger automotive grade cable to avoid cable deterioration or damage to the covering.
- Check that no metal objects (coins, tools, etc.) are left inside the unit to avoid short circuits.
- If you smell or see smoke, turn the power off immediately and consult your Kenwood dealer.
- Do not touch the unit during use because the surface of the unit becomes hot and may cause burns if touched.

▲ CAUTION

Take the following precautions to keep the unit in proper working order.

- Be sure the unit is connected to a 12V DC power supply with a negative ground connection.
- Do not open the top or bottom cover.
- Do not install the unit in places it is exposed to direct sunlight, high heat or humidity, water may splash over it, or dust exists.

NOTE

- If you have difficulty in installing this unit in your vehicle, contact your Kenwood dealer.

Cleaning the unit

- If the surface is dirty, wipe it clean with a silicon cloth or soft dry cloth with the power off.

▲ CAUTION

Do not use hard cloths or paint thinner, alcohol, or other volatile solvents. These may damage external surfaces or remove indicator characters.

FCC WARNING

- This equipment may generate or use radio frequency energy. Changes or modifications to this equipment may cause harmful interference unless the modifications are expressly approved in the instruction manual. The user could lose the authority to operate this equipment if an unauthorized change or modification is made.

Installation procedure

1. Remove the ignition key and disconnect the negative (-) terminal of the battery to prevent short circuits.
2. Connect the input and output cables of the units.
3. Connect the speaker cables.
4. Connect the ground cable and battery cable in the order listed.
5. Install the unit in the car.
6. Connect the negative (-) terminal of the battery.

▲ CAUTION

- If the fuse blows, check cables for shorts, then replace the fuse with one of the same rating.
- Check that no unconnected cables or connectors are touching the car body. Do not remove caps from unconnected cables or connectors to prevent short circuits.
- Connect the speaker cables to appropriate speaker connectors separately. Sharing the negative cable of the speaker or grounding speaker cables to the metal body of the car can cause this unit to fail.
- After installation, check that the brake lamps, wipers, and wipers work properly.

Accessories

Part name	External View	Number of Items
Self-tapping screws ($\phi 5 \times 18$ mm)		4

Controls

① LINE IN terminal

RCA input terminal. It can be used by setting the BALANCE INPUT CHANGEOVER switch as follows:
When the switch is set to UN-BALANCED position:

These sockets are L and R LINE IN
When the switch is set to BALANCED position:

These sockets are L+ and R+ LINE IN

② OUT terminal

RCA input/output terminal. It can be used by setting the BALANCE INPUT CHANGEOVER switch as follows:
When the switch is set to UN-BALANCED position:

These sockets are L and R LINE OUT
When the switch is set to BALANCED position:

These sockets are L- and R- LINE IN

③ RCA CABLE GROUND LEAD terminal

④ BALANCE INPUT CHANGEOVER switch

This switch selects between RCA terminal input and output.

To use LINE OUT, set this switch to the UN-BALANCED position.

To obtain a higher S/N ratio by connecting a commercially available balance converter, set this switch to the BALANCED position.

⑤ POWER CONTROL LEAD terminal

⑥ SPEAKER CABLE terminals

⑦ GROUND terminal

⑧ POWER terminal

⑨ FUSE

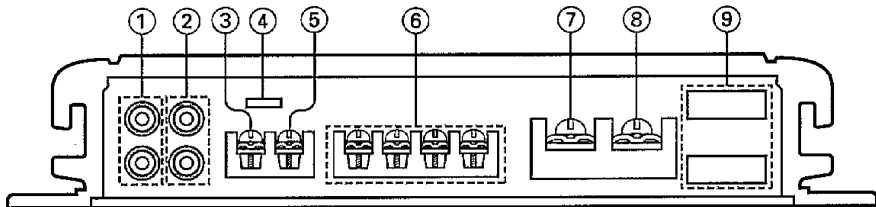

⑩ SPEAKER switch

This switch is used to set the impedance of the speaker that is to be connected.
To connect a 4-ohm speaker, set it to the "4Ω" position.

To connect a 2-ohm speaker or to bridge a speaker, set it to the "2Ω/BRIDGED" position.

⑪ COOLING FAN

When the unit's internal temperature rises, the built-in cooling fans automatically operate to cool the unit.

⑫ OPERATION switch

This switch allows selection of the amplification method of input signals.

• STEREO position

The amplifier can be used as a stereo amplifier.

• BRIDGED / L+R position

Bridge output (2 times) or L+R (Monaural) output can be produced.

• TRI-MODE position

The amplifier is used as a stereo amplifier, while bridge output (2 times) can be produced at the same time.

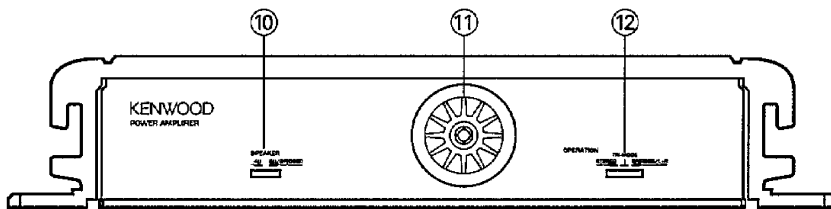

13 LOW PASS FILTER switch

When this switch is set to ON, the amplifier can be used to output only low frequencies. The output frequency can be adjusted with the LOW PASS FREQUENCY control. When the switch is set to ON, the amplifier automatically outputs monaural sounds (L+R).

14 POWER INDICATOR

When the power is turned on, the Power indicator lights. If the Power indicator does not light when the power is turned on, the protection function may be activated. Check whether there is any indication of trouble.

15 LOW PASS FREQUENCY control

Use this control to adjust the frequency band to be played when the LOW PASS FILTER switch is set to ON.

16 INPUT SENSITIVITY control

Adjust this control according to the pre-out level of the center unit connected to this amp.

NOTE

- Refer to "Specifications" on the center unit's instruction manual about the pre-out level.
- The level of the signal input to the amplifier through the balance converter is twice the level of that input directly from a normal receiver. Reduce the input sensitivity (preferably to 1/2).

Center unit preout level	Amplifier input sensitivity
300~1000 mV	MAX (0.3 V)
1.5 V	0.5 V
2~4 V	1.0 V

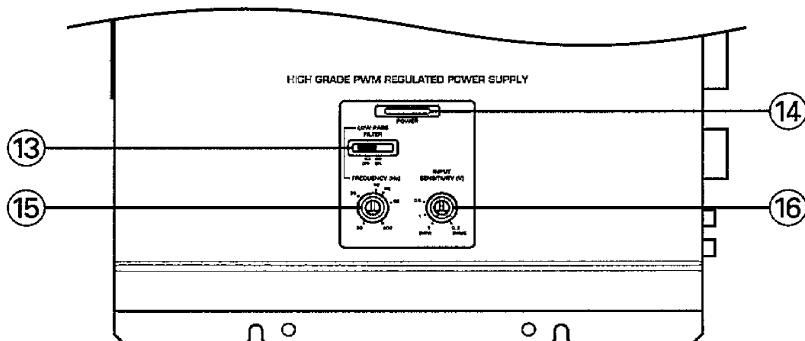

Balance input

A higher S/N ratio can be obtained by inputting signals to the amplifier through a commercially available balance converter.

To Input signals through a balance converter, be sure to set the BALANCE INPUT CHANGEOVER switch to the BALANCED position.

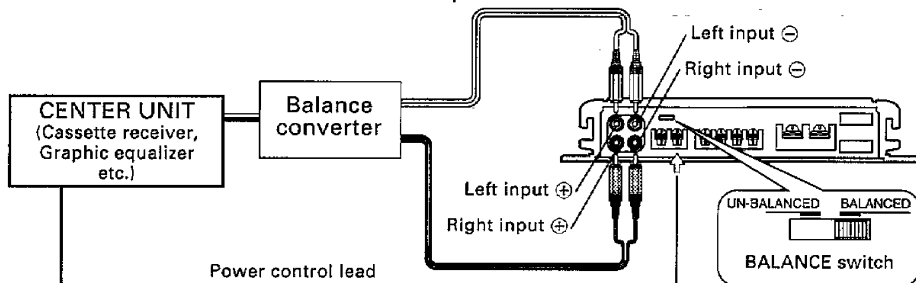

Using the RCA LINE IN and OUT terminals

You can connect a second amplifier to your system via the LINE OUT terminal. When using the LINE OUT terminal sure to set the BALANCE INPUT CHANGEOVER switch to the UN-BALANCED position.

■ System example

- Two amplifiers are used in system, with one used as a normal stereo power amplifier and the other as a subwoofer power amplifier.

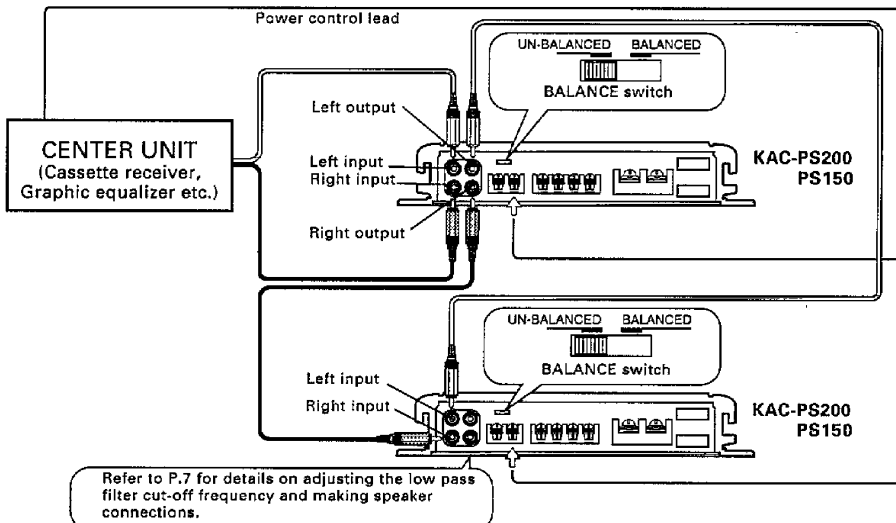

<Refer to P.10 for details on connections.>

Low pass filter system

If you use the low pass filter system, you can use the amplifier to output only low frequencies.

- ① Set the LOW PASS FILTER switch to ON. When the switch is ON, the amplifier automatically outputs monaural sounds (L+R).
- ② Adjust the output frequency with the LOW PASS FREQUENCY control.

• Subwoofer system for output frequencies of less than 90 Hz.

<Low pass filter adjustment>

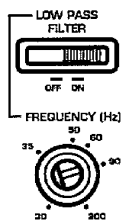

<Connection>

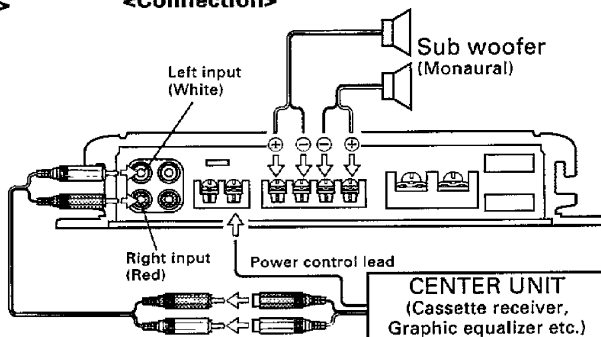

Protection function

This unit is equipped with a protection function for protecting this unit and your speakers from various accidents or problems that can occur. When the protection function is triggered, the Power indicator goes off and the amplifier stops operating.

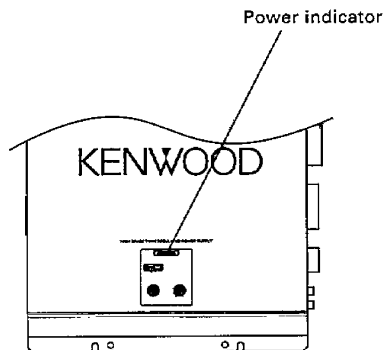

The protection function activates in the following situations:

- When a speaker output contacts ground.
- When the unit malfunctions and a DC signal is sent to the speaker output.
- When the temperature of internal parts exceeds 120°C (248°F)
[When the temperature exceeds 80°C (176°F), the cooling fans operate to cool the unit. However, if the temperature continues to rise regardless of the cooling fan operation, the protection function will activate to shut down the unit.]
- When a ground cable of the center unit (cassette receiver, CD receiver, etc.) or this unit is not connected to a metal part serving as an electrical ground passing electricity to the battery's minus ⊖ terminal.

Bridged / High power system

If speaker cables are bridge-connected while the operation switch is in the BRIDGED/L+R position, the output power can be doubled. This feature allows to construct a system with higher power.

Operation switch



■ High power system 1

The high-power monaural (two times the general output sound) can be obtained.

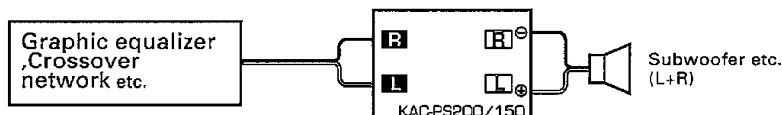

■ High power system 2

When two KAC-PS200/150s are connected, high-power output stereo sound can be obtained.

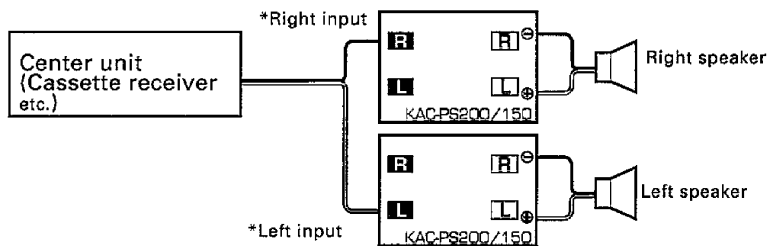

*You can obtain the same output level if you use either channel "L" or "R".

▲ CAUTION

If you wish to bridge-connect speakers, the impedance of each speaker must be no less than 4 ohms.

If the speakers are bridge-connected as shown in the above figure, the speaker impedance as seen from the amplifier unit is half the actual impedance. Therefore, if you use a speaker with an impedance of 2 ohms, since the impedance as seen from the amplifier unit is 1 ohm, it may result in a failure of the amplifier.

Tri-mode

With the KAC-PS200/150, a subwoofer can be added easily to the speaker system by making use of the properties of coils and capacitors. This mode of operation is called Tri-mode.

■ Principle of Tri-mode

● Method of frequency band division using a coil capacitor

...in case of 6dB/oct. slope

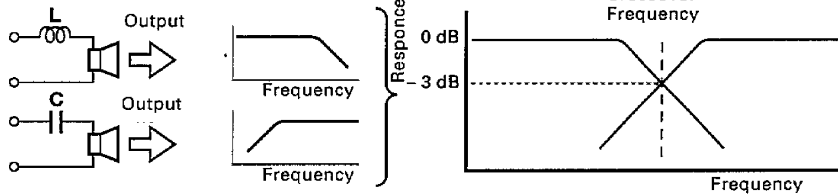

- Coil (L): Passes low frequencies and blocks high frequencies. (Low pass)
- Capacitor (C): Passes high frequencies and blocks low frequencies. (High pass)

● Your coil and capacitor

Use the following formula to identify the coil and capacitor you need in your system.

$$C = \frac{159000}{f_c \times R} \quad (\mu\text{F}) \quad L = \frac{159 \times R}{f_c} \quad (\text{mH})$$

f_c = Cut of Frequency (Hz) R = Speaker Impedance (Ω)

Example: When it is required to set a crossover frequency of 120 Hz using speakers with an impedance of 4 ohms.

Prepare commercially-available coil and capacitor with the closest ratings to the results calculated from the formula above. The capacitor rating should be as close as possible to 331.25 (μF) and the coil rating should be as close as possible to 5.3 (mH).

■ System example

To use the Tri-mode configuration, set the OPERATION switch to the TRI-MODE position.

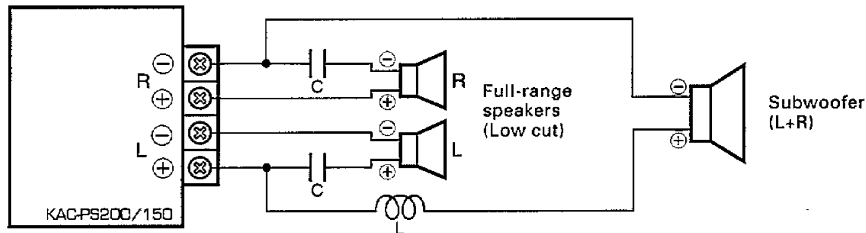

▲ CAUTION

If you wish to bridge-connect a speaker, such as a subwoofer, as shown above, the speaker impedance must be no less than 4 ohms.

If a speaker is bridge-connected as shown, the impedance as seen from the amplifier unit is half the actual impedance. Therefore, if you use a speaker with an impedance of 2 ohms, since the impedance as seen from the amplifier unit is 1 ohm, it may result in a failure of the amplifier.

Connection

System connection

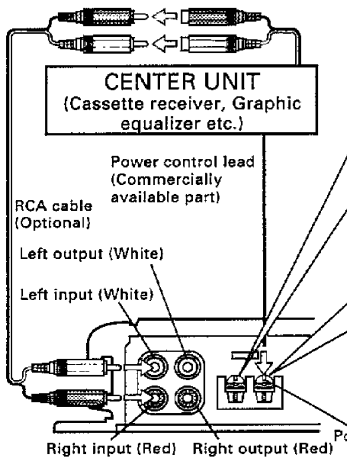

RCA cable ground lead terminal

When using an RCA cable with a ground lead attached, connect the ground lead to this terminal.

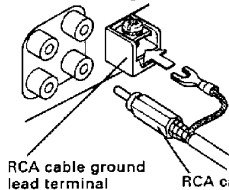

CAUTION

Do not use this terminal for power source grounding. This unit will be damaged if the power source grounding wire is connected to this terminal.

Power control lead terminal

Connect the Center unit's power control lead from the center unit.

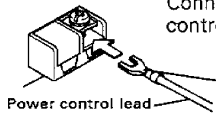

Power and Speakers cable connection

Speaker cable terminal

Connect the speaker cables to these terminals.

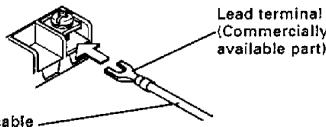

Operation switch	Speaker terminal polarity			
STEREO position	L ⊕	L ⊖	R ⊖	R ⊕
Tri-mode position	L ⊕	L ⊖	R ⊕	R ⊖
L+R position	⊕	⊖	⊖	⊕

Power terminal

Connect the Battery cable and Ground cable to the corresponding terminals.

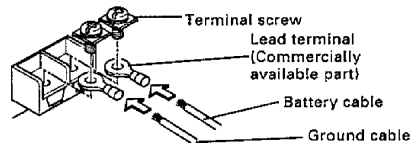

Ground terminal Power terminal

NOTE

Connect the ground cable to a metal part of the car chassis that acts as an electrical ground passing electricity to the battery's minus ⊖ terminal. Do not turn the power ON if the ground cable is not connected.

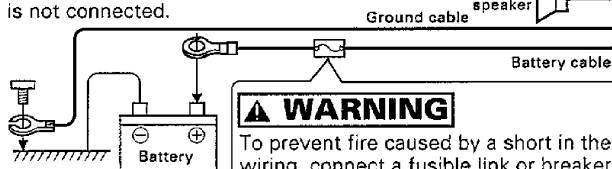

WARNING

To prevent fire caused by a short in the wiring, connect a fusible link or breaker nearby the battery terminal.

Battery cable



Line noise filter (Optional)

If a buzzing noise is heard from the speakers when the engine is running, connect a line noise filter (sold separately) to each of the battery cable.

Installation

■ Installation

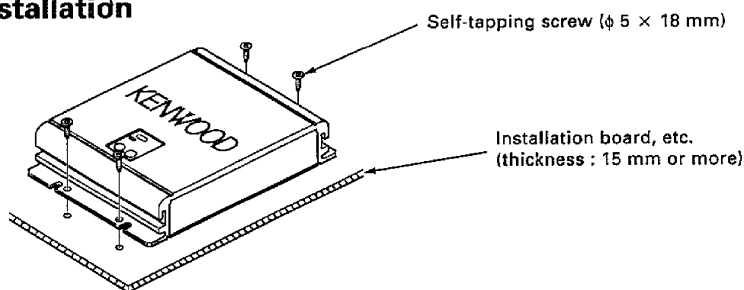

▲ CAUTION

Do not install the unit under the carpet. Otherwise heat build-up occurs and the unit may be damaged.

■ Installation location

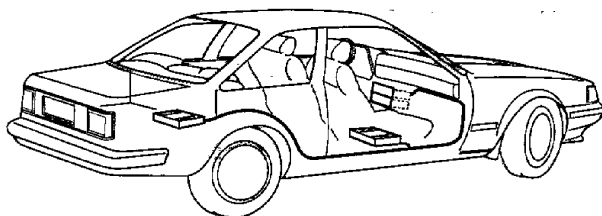

- Since the power amplifier has no parts which require operation, it can be installed at a position away from the driver's seat without any hindrances.
As generally accepted positions for its installation, places such as inside the trunk, etc. can be considered.

▲ CAUTION

- Install this unit in a location which allows heat to easily dissipate.
Once installed, do not place any object on top of the unit.
- If the internal temperature of the unit rises, the cooling fan runs automatically to reduce the temperature.
When installing the unit, do not block the cooling fan outlet. If it is blocked, the internal temperature cannot be reduced, resulting in a failure of the unit.

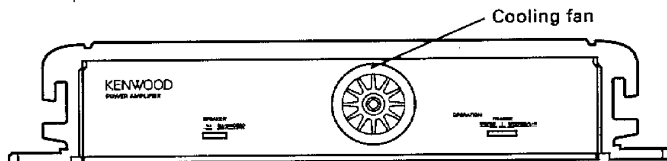

- After installing the unit, check to make sure that electrical equipment such as the brake lamps, turn signal lamps and windshield wipers operate normally.
- Install the unit securely in a location that does not interfere with driving.

Troubleshooting guide

Often, what appears to be a malfunction is due to user error. Before calling for service, please consult the following table.

Symptom	Cause	Remedy
No sound. (No sound from one side.)	A speaker cable has become unconnected.	Connect the speaker cable again.
The output level is too small (or too large).	The input sensitivity adjusting control is not set to the correct position.	Adjust the control correctly referring to "Controls".
The sound quality is bad. (The sound is distorted.)	The speakers cable are connected with wrong \oplus/\ominus polarity.	Connect them properly checking the \oplus/\ominus of the terminals and cables well.
	A speaker cable is pinched by a screw in the car body.	Connect the speaker cable again so that it is not pinched by anything.

**Beat noise is heard
When listening to AM
radio broadcasts.**

Use a screwdriver to adjust the "Beat Canceled" on the bottom of the unit.

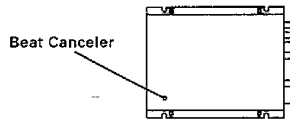
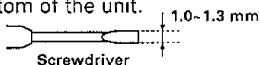

Specifications

Specifications subject to change without notice.

Audio Section	KAC-PS200	KAC-PS150
Max Power Output (4 Ω)		
Normal	200 W \times 2	150 W \times 2
Bridged	600 W \times 1	440 W \times 1
Rated Power Output (4 Ω)		
Normal (20 Hz ~ 20 kHz less than 0.05 % THD) ..	100 W \times 2	75 W \times 2
Bridged (1 kHz less than 0.3 % THD)	300 W \times 1	220 W \times 1
Rated Power Output (2 Ω)		
Normal (1 kHz, less than 0.3 % THD)	150 W \times 2	110 W \times 2
Frequency Response (-3 dB)	5 Hz ~ 50 kHz	5 Hz ~ 50 kHz
Sensitivity (rated output) (MAX.)	0.3 V	0.3 V
(MIN.)	5.0 V	5.0 V
Signal to Noise Ratio	105 dB	105 dB
Input Impedance	10 k Ω	10 k Ω
Damping Factor (100 Hz)	More than 200	More than 200
Low Pass Filter Frequency	30 ~ 200 Hz (variable)	30 ~ 200 Hz (variable)
General		
Operating Voltage	12.0 V (11 ~ 16 V allowable)	12.0 V (11 ~ 16 V allowable)
Current Consumption	50 A	36 A
Dimensions (W \times H \times D)	297 \times 56 \times 270 mm (11-11/16 \times 2-3/16 \times 10-5/8 in.)	297 \times 56 \times 240 mm (11-11/16 \times 2-3/16 \times 9-7/16 in.)
Weight	4.4 kg (9.7 lb)	3.9 kg (8.6 lb)

KENWOOD